









Legend Ventilation

	Outside air		Supply air
	Relief air		Exhaust air
	Sound absorber		Fire damper
	Shut-off flap		Variable volume box
	Multi-leaf damper		Weather resistant louvre

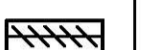
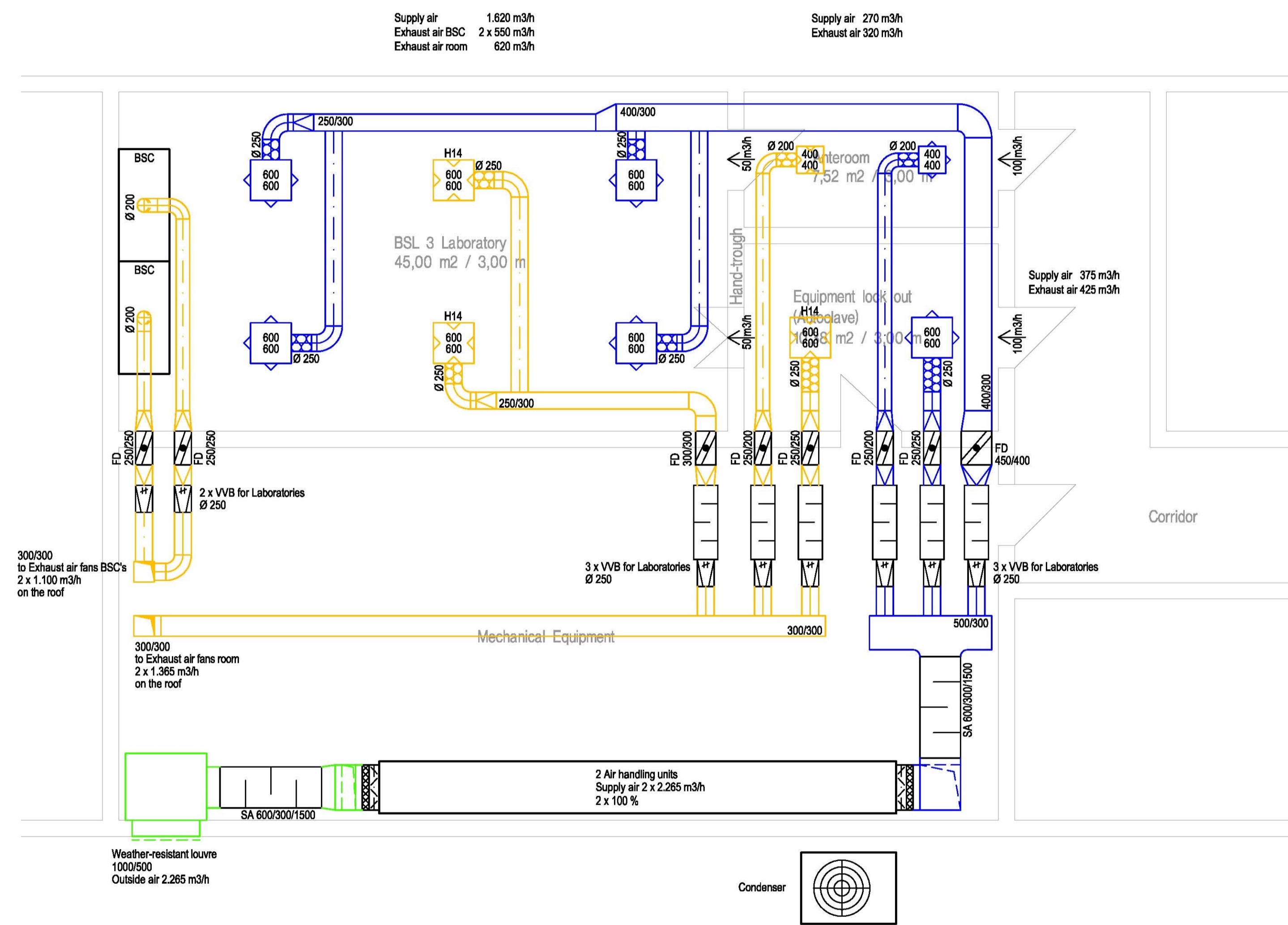

Leistungsbereich	Masstab:	Status:
Ventilation	1:50	

Planinhalt
TBC diagnostics laboratories
 Standard design
 Ventilation
 Floor plan

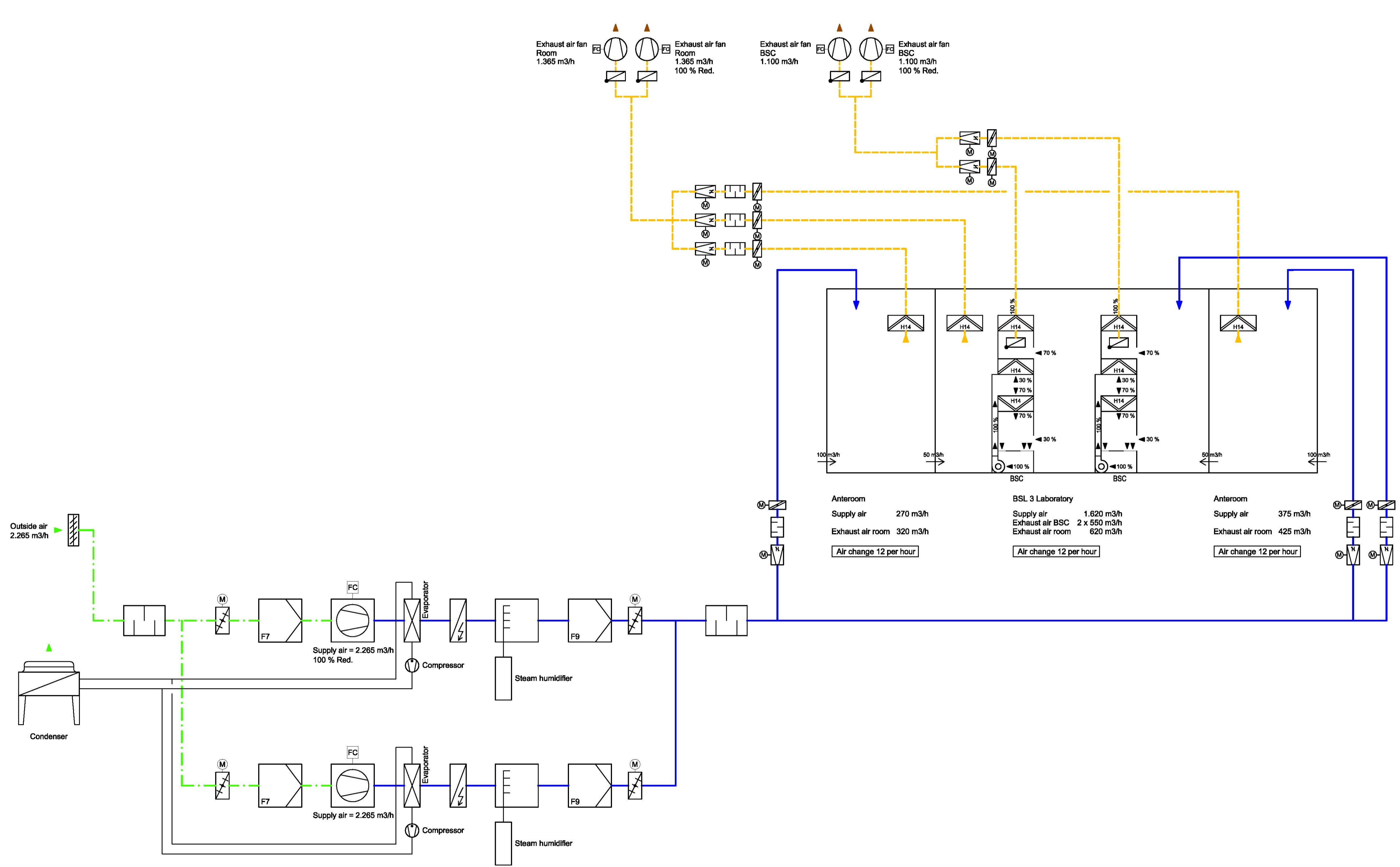

Legend Ventilation			
	Outside air		Supply air
	Relief air		Exhaust air
	Fan		Non-return damper
	Filter F7		Multi-leaf damper
	Filter F9		Fire damper
	Filter H14		Variable volume box
	Sound absorber		Weather resistant louvre
	Heater ELT		Frequency converter
	Cooler		Motor
	Steam humidifier		

Leitungsbereich: **Ventilation**
 Mossetab: **1: --**
 Status:
 Planinhalt:
TBC diagnostics laboratories
Standart design
Ventilation
Schematic diagram